



NETWORK SAFETY SOLUTIONS

MAXIMISING YOUR EFFICIENCY. MINIMISING YOUR COSTS. PROTECTING YOUR SYSTEM.





CONTENTS

	Page Number
AVK UK Network Safety Solutions.	3
Common Issues.	
- Vacuum.	4
- Air Entrainment.	5
- Water Hammer.	6
Selecting The Right Valve.	
- Air Valves.	8-13
- Automatic Control Valves.	14-19
- Non-return Valves.	20-25
Associated Products.	26-27
Engineered Solutions	29

AVK UK NETWORK SAFETY SOLUTIONS



The water industry is under pressure to continually develop its approach to managing and operating assets to meet the challenges of resilience.

By extending the life of water utilities assets and developing robust systems that avoid premature failures, whilst integrating adaptable networks to meet new challenges and operating conditions, water utilities can save money on;

- Replacement of the asset.
- Manage the existing asset, to react to a changing environment.
- Plan for the future by creating a more resilient high performance water utilities system.

Selecting the correct valve

Selecting the correct valve in both diameter and type will allow water utilities to manage their networks more efficiently during any 24 hour period, and it is here that the valve manufacturer's knowledge of how best to use his own product really pays dividends.

There are several valve types that are used to protect water systems from the onset of damaging phenomena such as water hammer, air entrainment and vacuum pressures. These conditions will seriously affect system performance, ranging from reduced efficiency to catastrophic system failure. The correct valve type, size and installation in the correct location can ensure that your system will operate effectively, efficiently and safely throughout its operational lifetime.

Network Safety Solutions

AVK's Network Safety Solutions offer has been developed to help the industry efficiently and safely meet its targets, whilst reducing leakage and service failure across maintenance and replacement activities, taking into account the OFWAT directives and changing environment.

As the catastrophic and dramatic failures make the news, every failure impacts on the network's performance. The purpose of this guide is to help network operators and designers minimise the risks of network failure and extend the life of their assets.

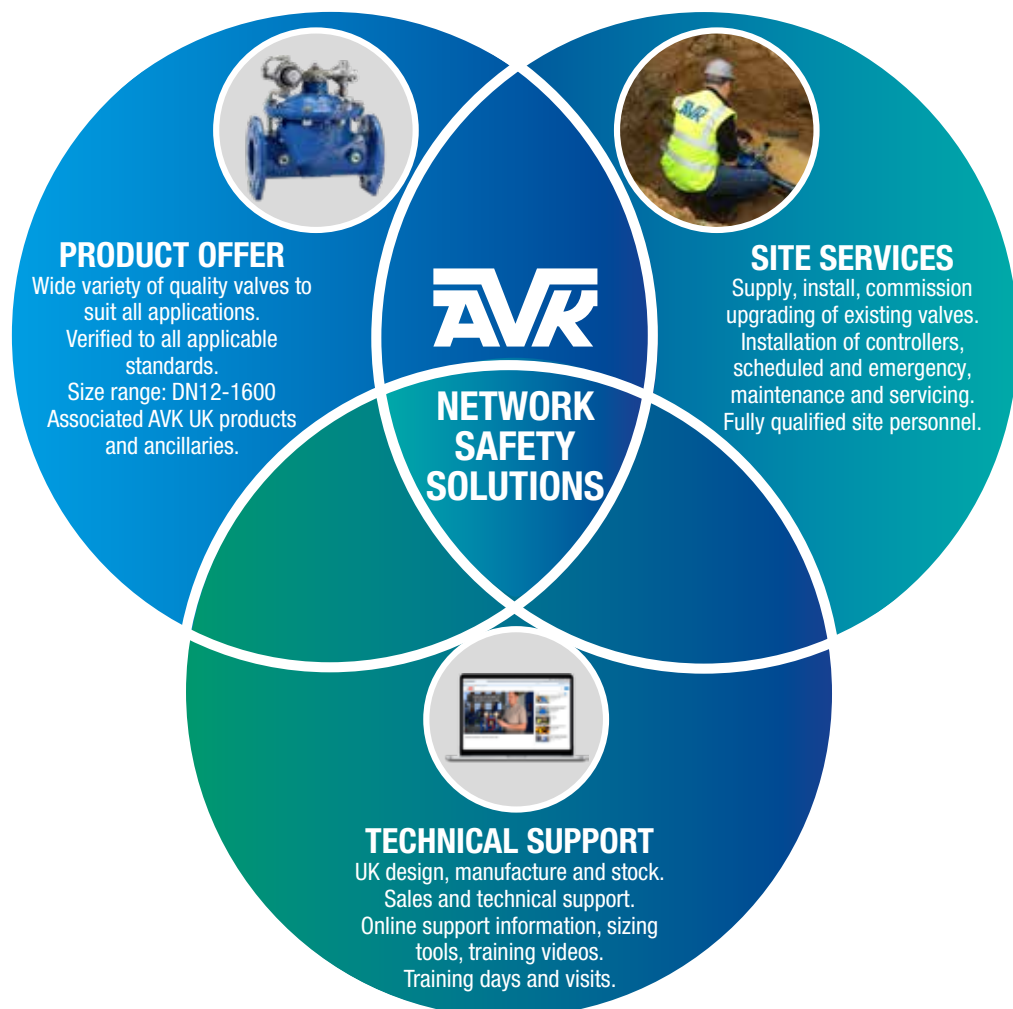

NETWORK SAFETY

COMMON ISSUES



VACUUM

Negative pressure in a pipeline causes it to implode and buckle in extreme conditions.

Vacuum can occur in pipes due to a lack of air in the system as shown in the images above and below, causing severe irreversible issues. This can be prevented by installing air valves.

Vacuum in a pressurised pipe system, can be caused by: inefficient air valves not reacting to hydraulic conditions, air valves having historically failed due to lack of maintenance and air valves being absent from the pipeline altogether. This occurrence can cause major damage to both the efficient performance of the pipeline and premature failure of the pipeline. Correctly sized and located air valves offer a solution to this issue.

Air valves are visually associated with the release of air from the system, and therefore commonly known as air release valves. However, this name is misleading as their other function, introducing air in to the system, is equally as important.

Associated common hazards

Apart from preventing the flow, the most common hazards of vacuum are:

1. Enhanced problems and damage to the pipeline causing:
 - a. Suction of contaminants, mud and dirt through faulty connections, cracks in pipes and accessories.
 - b. Suction of seals and gaskets, in-line fittings and other internal accessories of pipes.
 - c. Uncontrolled suction of injected chemicals into system.
 - d. Pipe or accessory collapse.
2. In some cases the absence of an air cushion can increase the damage of surge and slam phenomena. (See page 6).
3. Reduces whole life of pipe asset due to positive and negative pressures acting on the pipe wall. This can result in fatigue loading which will weaken and eventually cause failure of the pipe wall. This is especially important on ageing assets where the pipeline material degradation is likely.

Continuous air flow

Managing air discharge in the system requires the correct level of air discharge or vacuum break to ensure that air can be drawn back into the main during negative pressure situations. In an industry with ageing assets and a desire to extend the working life, negative pressures, left unmanaged, have been proven to cause additional issues that can extend to contaminated material or fluids in potable water pipelines via old joints or minor cracking of the mains.

Professor Joby Boxall in his joint report of 2015, demonstrated that three requirements that must coexist for contaminant ingress to take place within water distribution systems;

- The existence of a contaminant source external to the distribution pipe (contaminated ground water).
- A pathway providing a route into the system (failed or failing pipe joints or limited leaks).
- a driving force (negative pressures within the pipeline).

As such, to allow a system to remain unprotected from this form of contamination allows the potable water to run the risk of becoming contaminated.

One solution to this is to remove one aspect of the three requirements: the driving force. Air valves are the most efficient and cost effective tool to achieve this and by installing and maintaining a system of air valves, negative pressure is managed and removed from the equation, allowing the ageing network to remain protected.

Fox, Sam & Shepherd, Will & Collins, Richard & Boxall, Joby. (2015). Experimental Quantification of Contaminant Ingress into a Buried Leaking Pipe during Transient Events. *Journal of Hydraulic Engineering*. 142. 04015036. 10.1061/(ASCE)HY.1943-7900.0001040.

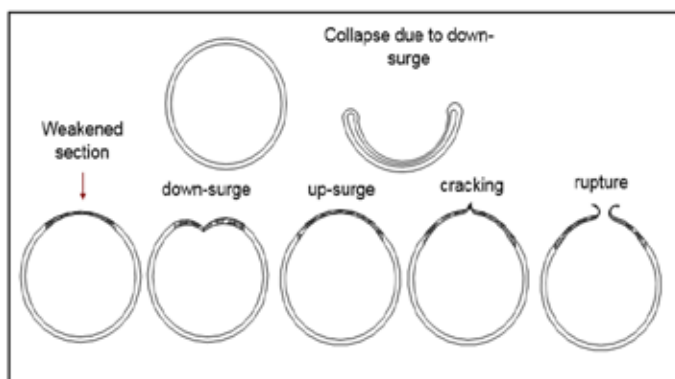

NETWORK SAFETY COMMON ISSUES



AIR ENTRAINMENT

Air collecting at high points of the system reduces pump efficiency, causes corrosion and then as it is pressurised will create a small area of very high force, which can ultimately burst pipes.

Air is present in all water and waste water pipelines. The air may be absorbed at free surfaces, or entrained in turbulent flow at the entrance to the line, changes in direction or incline. The air may therefore be in the water or in the form of bubbles or pockets.

Air pockets

An air pocket implies a relatively large volume of air, likely to accumulate on top of the pipe cross section. The pockets may travel along the line to peaks. Where they will either remain in equilibrium, be entrained by the flowing water or be released through air valves.

Air valves are globally recognised as the most effective airflow control valve associated with fluid dynamics. Their contribution to efficient flow of fluids engage with energy savings, extension of the pipeline asset life and management of surge characteristics that can damage new and older pipelines.

Some of the issues and essentially dangers attributed to the presence of air within pressurised pipe systems can be categorised as follows:

- Reduction of effective bore of pipeline, causing in extreme cases complete blockages.
- Measurable energy losses.
- Water hammer or localised surges. (See page 6).
- Meters being affected and misreading flows in conjunction with premature failure due to internal damage to meters.
- Localised reduction in water supply or pressure
- Extensive corrosion of pipeline resulting in premature failure.
- Excessive localised pressures that could cause a danger to operators during maintenance or operation.

Eliminating the air

Air valves are frequently used to eliminate the air that is on the crown of the pipe or at changes in incline. Air valves are classed in three basic designs:

- Kinetic or large orifice, used to release large quantities of air during the filling of the line and to draw air in from the atmosphere during vacuum conditions in the line.
- Automatic or small orifice, the part of the valve that will continue to operate when the pipeline is under full pressure and releases small volumes of high pressure air and double orifice or combination air valve, which combines kinetic and automatic into one valve. (See page 10).

Recommended locations of the air valves would be categorised as follows;

- Pump stations: after the pump and after the check valve.
- After and before shut-off valve.
- After deep-well pump.
- On long hydraulic gradient water supply lines.
- At peaks relative to hydraulic gradient.
- At the end of lines.
- Before water meter.

Air bubbles

The air bubbles themselves often form in the following locations or are caused by conditions within the system:

- At a throttle or orifice.
- Where there is a pressure drop.
- At a branch or pipe joint.
- From a valve opening and closing rapidly.
- From shock waves, due to sudden closing of valves or cessation of pump operation.
- Pressure drop at the pipe end, due to sudden opening of valve.



NETWORK SAFETY COMMON ISSUES



WATER HAMMER

Typically caused when a body of water hits an obstacle; for example a valve which is closed too quickly, will send a shock wave along the pipe with the potential to destroy both the pipe and equipment.

Water Hammer occurs due to a rapid deceleration of forward velocity in the pipeline system. This creates a shock wave of inert energy within the fluid and a hammering noise in the pipe system. This can cause a localised increase in pressure and will continue to travel along the pipeline until the energy has dissipated.

Reducing water hammer

The risk of water hammer can be greatly reduced by operating the valves in a controlled, slow manner and managing the potential hammer scenario. Using a selection of various automatic valve types, each of which provide protection to the system in different ways as follows:

Air Valves (Series 701)

In system locations where water column separation can occur. When separation occurs, for example a pump trip scenario, the air valve will allow a considerable volume of air into the pipeline to avoid vacuum, but can also restrict the exhalation of air into the atmosphere so that when two high-energy water columns re-join, atmospheric damping takes place to prevent pressure surges. (See pages 12, 13).

Automatic Control Valves (Series 879)

Surge anticipating valves have specially designed pilot systems that automatically senses when a high pressure event will occur, for example, on a pumped system. The pilot opens the main valve allowing maximum flow through the valve until the pressure reduces sufficiently. The main valve then closes slowly to prevent the risk of water hammer. (See pages 18, 19).

Non-return Valves (Series 41/641/876)

To prevent flow reversal entering into the pump, well or intake, the rate of fluid reversal is not a cause for concern and standard check valves will perform well, however, in pumped systems where fast flow reversal can occur, the selection of the correct check valve is crucial. (See pages 24, 25).

Pressure wave surge

If a pump stops and the forward flow reverses back down the line towards the pump before the check valve has fully closed, the flow will force the valve door to slam onto its seat. This scenario can almost instantaneously stop the reverse flow and it is this instantaneous stoppage which results in pipeline water hammer.

This can produce loud hammer noises which is not the noise of the valve coming into its seated position but is the stretching of the pipe under these conditions. The consequent pressure wave (surge) can cause considerable damage to the system including pipe cracks, bursts, cavitation and implosion due to vacuum pressures being formed. It is also important to note that these failures may not be due to one single, large surge pressure but by repeated surges which eventually cause fatigue failure of the system.

Safe and trouble free system- check valve slam

To prevent the occurrence of check valve slam, the valve should close in a quick, controlled manner to prevent the onset of reverse flow or very slowly once reverse flow has developed. For a check valve to close slowly, this requires additional ancillary equipment such as hydraulic dampers which act to cushion the valve door as it comes into its seated position.

This slower closure does allow the fluid to pass through the check valve until it closes and consideration must be given to the upstream pump to ensure that it is suitable for reverse spin, flow and potential damage to upstream fittings.

VALVE OPEN - WATER MOVING

QUICK VALVE CLOSURE - WATER HAMMER

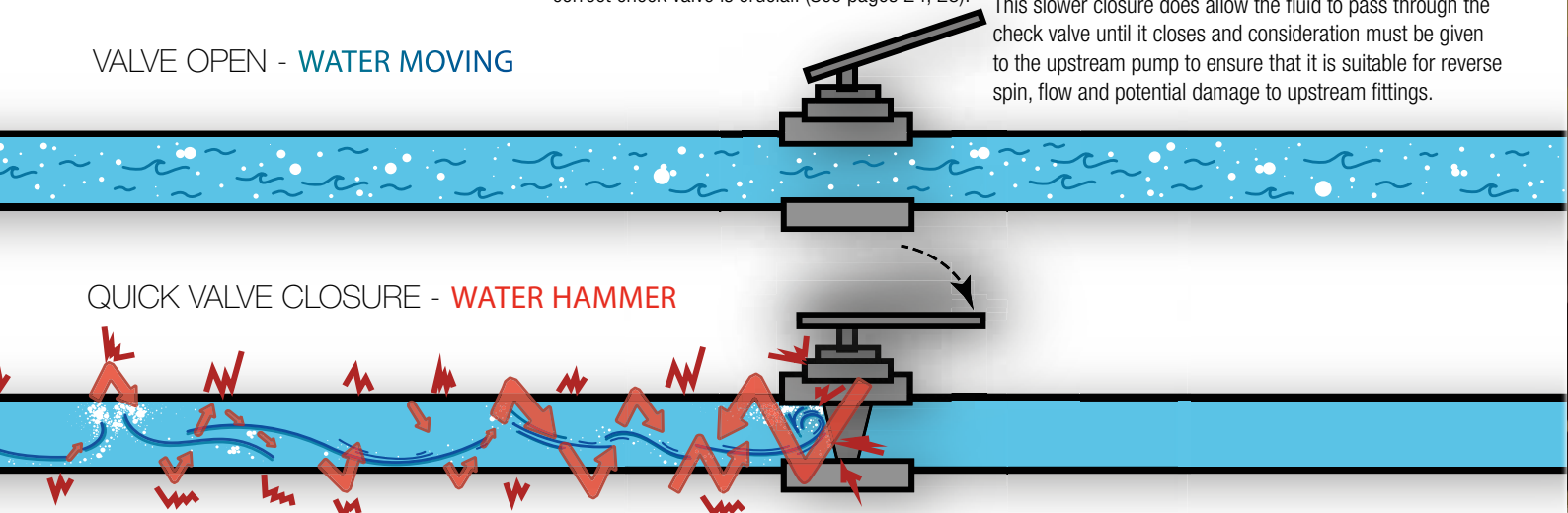

NETWORK SAFETY

WE ARE HERE TO HELP



Vaccum, Air Entrainment and Water Hammer are the common causes of pipeline failure. These issues can be solved by a combination of product types, sizing and installation locations.

The next section of this document provides the most applicable solutions to the issues highlighted in the previous sections.

The impact of network failure extends far beyond service delivery. When a pressurised main fails the physical safety of water company personnel and the general public is at risk. Repairs are invariably costly and there is the opportunity cost of what those monies could have been used for elsewhere on the network.

Customers may have to be compensated, OFWAT KPI's take a hit and the negative publicity damages the water utility's reputation. We are here to help.

Choosing the right valve

Whilst the basic functions of air valves – allowing air to leave or enter the network – control valves – regulating pressure and flow – and check valves – protecting upstream assets – are straightforward, ensuring you choose the right one for your specific application can be daunting.

Expect solutions not only products.

A 'solution' is needed when there is choice. Our role as valve experts is to use our knowledge and experience to ensure you choose the right valve for the right application: to keep your network safe.

Just some of the criteria which influences the specification of the correct valve include:

- Pipe diameter.
- Material.
- Flow rate.
- Head.
- Pressure wave velocity.
- Spacing between valves.
- Valve material.

How can AVK help?

Option 1 – The gold standard! You talk to an AVK engineer on +44 (0) 1604 601188. AVK has a team of experienced product specialists to walk you through the specification process.

Option 2 – You visit www.avkuk.co.uk and download our product brochures, watch our educational videos, read our case studies and technical papers. There are QR codes in this guide which can will take you directly to these resources.

Option 3 – AVK Product Training courses; you can come to us, or we'll come to you. Educating, sharing, understanding and free of charge. Talk to us +44 (0) 1246 479100.

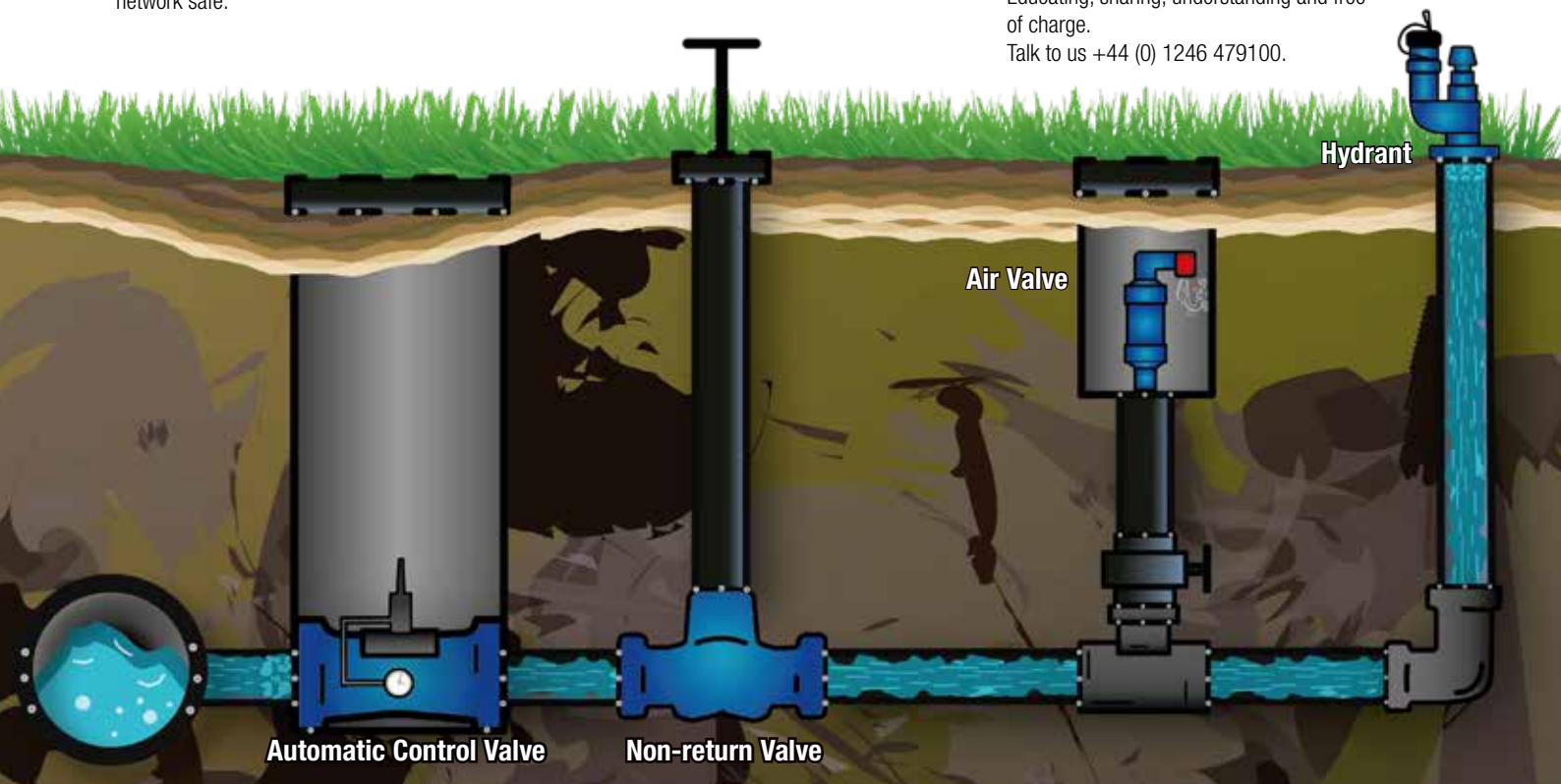

AVOIDING NETWORK ISSUES

VACUUM AND AIR ENTRAINMENT

How can AVK Air Valves help?

Air valves are used to improve the performance and asset life of pipe systems. Primarily they manage the air discharge, increasing system efficiency and to draw air back into the pipeline to negate any vacuum conditions caused by negative pressures. The correct air valve provides protection from transient pressures and entrapped air in pipelines, the main cause of bursting, collapsing and fracturing of pipelines. (See pages 4 & 5).

These negative effects on pipeline assets can be directly associated with reduced pipeline efficiency, premature failure and increased whole life costs. Air valves will effectively allow air to be expelled as well as introduced into a pipeline during the many phases of operation including filling, pumping and emptying.

Issues caused by air inside water pipes.

They include:

1. Impedance of flow in pipelines – up to complete stoppages.
2. Serious head losses – energy losses.
3. Water hammer damage.
4. Inaccurate readings in water meters.
5. Inadequate supply of water to areas in the system:
 - a) Due to air obstruction, flow and accumulation of pressure losses.
 - b) Due to faulty meter readings.
6. Serious damage to internal components of meters.
7. Corrosion and cavitation.
8. Physical danger to operators from air blown flying parts and from high velocity escaping air.

Absence of air

However, the absence of air in pipes can also be dangerous as it can create vacuum which can cause severe damage to the pipe as well as introduce contaminants to the system.

Air Valve application

Air valves should generally be used whenever there is a rapid change in velocity i.e. water pump or at high points in the system as air tends to move upwards and will therefore naturally accumulate at the highest points in the system.

As a by-product of the use of the air valves, AVK and our partners have developed an integrated system that avoids the need to construct a dedicated chamber and removes the need for man entry systems. The valve system produces and installation saving and reduces the cost and man power for future maintenance requirements. This system also allows for water and waste water valves and incorporation of surge support designs within the valves.

Recommended locations of the air valves would be categorised as follows;

- Pump stations: after the pump and after the check valve.
- After and before shut-off valve.
- After deep-well pump.
- On long hydraulic gradient water supply lines.
- At peaks relative to hydraulic gradient.
- At the end of lines, and before water meter.



CHOOSING THE CORRECT... AIR VALVE

Air Valve Sizing

Air valves should always be sized according to the volume of air within the pipeline and not just the size of the pipeline. Control of accumulated air within any pipe system will extend the whole life of the pipe system, deliver lower operational costs, reduce health & safety risks and achieve more efficient hydraulic performance. AVK offers the most comprehensive range of air valves on the market with a sealing range of 0.02 Bar minimum. We offer inlet sizes across our range sizes from DN12 to DN600, BSP and NP16 flanged inlets.



Small Single Orifice (Series 701/10,13)

The Automatic Air Release Valve releases accumulated air from the system while it is under pressure. The valve's unique design enables the separation of the liquid from the sealing mechanism by building an air gap, assuring optimum working conditions. AVK automatic air valves are designed with a very soft and sensitive seal. This enables effective discharge of accumulated air from the system while it is under pressure. Available in a variety of materials; reinforced nylon, brass, cast/ductile iron or stainless steel.



Kinetic, Large Single Orifice (Series 701/30)

The Large single orifice series Air & Vacuum Valve discharges air during the filling or charging of the system and admits air into the system during system drainage, valve or pump shut-off or at water column separation.

This allows for air to be released in large volumes from pipelines usually at the filling process, once the system becomes pressurised typically this valve will remain closed. It will only open once the system becomes depressurised and the valve will open allowing large volumes of air to be brought back into the pipeline, breaking any vacuum that has been created. Available in a variety of materials; cast/ductile iron, with a number of coatings available relating to the environment of operation. This type of valve is often fitted just after a pump.



Double Orifice, Combination (Series 701/40, 50,60)

AVK combination air valves are combined air release and vacuum valves. The air release function releases accumulated air from the system while it is under pressure. The air and vacuum function discharges and admits large volumes of air during the filling or draining of pipelines. The valve will open to relieve negative pressures whenever water column separation occurs. The body and all operating parts are made of specially selected corrosion-resistant materials.

The valve's unique design enables the separation of the liquid from the sealing mechanism and assures optimum working conditions.



Vented Non-Return Valve (Three-stage Capacity Air Discharge) (Series 970)

Function 1. One-way In.

One-way in, the shaft and spring are above the disc. The disc of the check valve is normally in the closed position, not allowing air discharge. When the negative differential pressure across the check valve is higher than the force of the spring, the check valve opens, allowing air intake into the air valve.

Function 2. One-way Out.

One-way out, the disc is on top, with the shaft and spring below. The disc of the check valve is normally closed and opens only when the differential pressure across the check valve is higher than the force of the spring, allowing air to discharge from the valve. The check valve does not open for air intake.

Function 3. Non-Slam.

Air discharge capacity is controlled by the discharge of air through the outlet. The vented component has three small holes (orifices) that can be closed or opened / or the disc has three or more holes that are permanently open.

CHOOSING THE CORRECT... AIR VALVE

AVK UK OFFER FREE TECHNICAL SUPPORT IN ADDITION TO A SIZING TOOL "THE ARICAD" TO HELP YOU MAKE THE RIGHT CHOICE:



This easy to use software produces reports for engineers as well as procurement teams. With the correct system information, we can help you identify the best product for your scheme; the most suitable location and offer advice on discharge, rupture and inflow characteristics.

Scan Here to learn more.



Pressure plots before and after air valve installation. (Blue line with air valve).

Pressure Plot at Pump Discharge

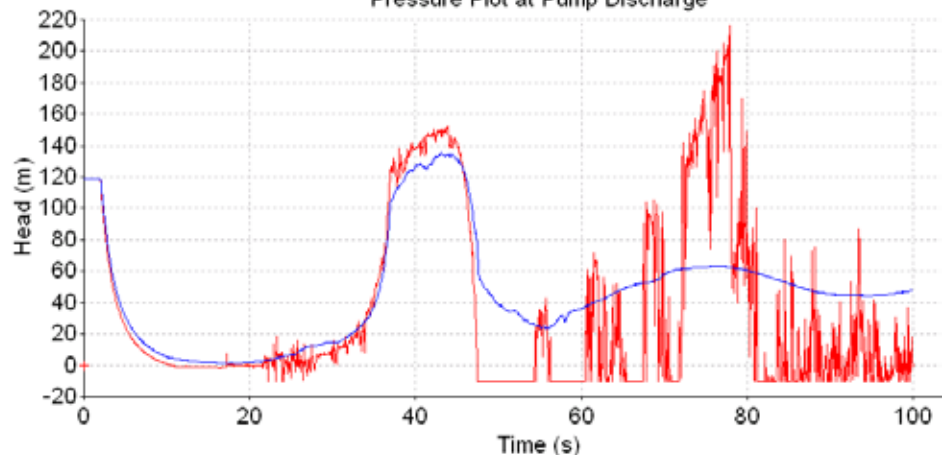

AIR VALVES ALL THE RANGE



SERIES 701/10

AVK Automatic Air Valve
For use in water
DN12-DN25
PN16
Minimum sealing pressure 0.2 bar
60 (m3/h)
Reinforced Nylon
Lightweight and compact single orifice air release valve, enabling effective discharge of accumulated air in pressurized systems.



SERIES 701/13

AVK Automatic Air Valve
For use in water
DN12-25
PN16
Minimum sealing pressure 0.2 bar
5000 (m3/h)
Cast Iron
Compact and durable single orifice air valve with a body of cast iron and brass base.



SERIES 701/30

AVK Air and Vacuum Valve
For use in water
DN100-DN300
PN16
Minimum sealing pressure 0.2 bar
5000 (m3/h)
Ductile Iron
Dynamic design allows for high velocity air discharge while preventing premature closure.



SERIES 701/40

AVK Double Orifice Composite Material Air Release Valve
For use in water
DN12 - DN50
¾, 1, 2" inlet,
PN16
Minimum sealing pressure 0.2 bar
300 (m3/h)
Reinforced nylon
BS EN 1074-4
Lightweight, corrosion resistant double orifice air valve designed for ease of use and transportation while maintaining excellent performance.



SERIES 701/40L

AVK Double Orifice Air Release Valve
For use in water
DN12 - DN50
PN16
Minimum sealing pressure 0.02 bar
300 (m3/h)
Reinforced Nylon
BS EN 1074-4
Lightweight, corrosion resistant double orifice air valve designed to cope with very low sealing pressures and raw water.



SERIES 701/46

AVK Double Orifice Air Release Valve
For use in Water
DN50 - DN100
PN16
Minimum sealing pressure 0.1 bar
2000 (m3/h)
Ductile Iron
BS EN 1074-4
BS EN 1092-2 (ISO 7005-2)
Ductile iron double orifice air valve designed to cope with very low sealing pressures and high flow rates.



SERIES 701/48

AVK Double Orifice Air Release Valve
For use in water
DN50
PN16
Minimum sealing pressure 0.1 bar
400 (m3/h)
Reinforced Nylon
BS EN 1074-4
Lightweight, corrosion resistant double orifice air valve designed to cope with very low sealing pressures.



SERIES 701/50

AVK Double Orifice Air Release Valve
For use in water
DN50 - DN200
PN16
Minimum sealing pressure 0.2 bar
600, 1400, 2500 (m3/h)
Ductile Iron
BS EN 1074-4
BS EN 1092 (ISO 7005-2)
Double orifice ductile iron air valve designed to handle very high flow rates.



SERIES 701/84

AVK Underground Air Release Valve with Underground Chamber
For use in water
DN50 - DN80
PN16
Minimum sealing pressure 0.1-10 0.2-16 bar
PVC/ Reinforced nylon
BS EN 1074-4
BS EN 1092-2 (ISO 7005-2)
The large orifice in the automatic valve releases large volumes of air at high flow rates when the line is under pressure.



FLOOD GUARD

Self Operating Flood Guard for Air Release Valve
For use in water
2" - 4"
PN16
Stainless Steel / Reinforced Nylon

AIR VALVES ALL THE RANGE



SERIES 701/60

AVK Combination Air Release Valve
For use in water
DN50 - DN80
PN16
Minimum sealing pressure 0.2 bar
1400, 3250, 5500 (m³/h)
Cast Iron
BS EN 1074-4
BS EN 1092 (ISO 7005-2)
Ductile iron air valve designed to handle very high flow rates and operating pressures.



SERIES 701/70

AVK Combination Air Release Valve
For use in wastewater
DN50 - DN200
PN16
Minimum sealing pressure 0.025 bar
300 (m³/h)
Mild steel epoxy coated
BS EN 1074-4
BS EN 1092 (ISO 7005-2)
The large air gap between liquid and sealing system ensures a reliable function even when used with aggressive liquids and liquids carrying solid particles.



SERIES 701/78

AVK Large Combination Air Release Valve
For use in wastewater
DN80-200
PN16
Minimum sealing pressure 0.02 bar
1500 (m³/h)
Steel
BS EN 1074-4
BS EN 1092-2 (ISO 7005-2)
Ductile iron double orifice waste water air valve.



SERIES 701/75

AVK Squat Combination Air Release Valve
For use in wastewater
DN50 - DN80
Minimum sealing pressure 0.05 bar
300 (m³/h)
PN10
Reinforced nylon
BS EN 1074-4
Popular lightweight squat version of the double orifice wastewater air valve, designed to cope with very low sealing pressures.



SERIES 701/79

AVK Underground Air Release Valve System
For use in wastewater
DN80 - DN100
PN10/16
Reinforced Nylon
BS EN 1074-4
Built-in safety, as it is not possible to extract the air valve unless the shut-off valve is closed and the internal pressure is released.



SERIES 701/95

AVK Combination Air Release Valve
For use in wastewater
DN50 - DN80
PN16
Minimum sealing pressure 0.05 bar
300 (m³/h)
Reinforced Polyamide
BS EN 1074-4
BS EN 1092-2 (ISO 7005-2)
Elongated waste water air valve, lightweight and designed to cope with very low sealing pressures.



AVK AIR VALVES

OPERATION & INSTALLATION



AVK air valves offer an automatic “rolling seal” design feature, allowing a more reactive performance to the variances of fluid pressures and conditions. On the large orifice valves, the main float is designed to remain open longer, allowing more air to escape and an EPDM seal that is formed to seal around the outer edge of the float, again offering improved performance on traditional designs and requiring a lower minimum line pressure to secure tight seal.

Pressures

Maximum pressures are key in any valve selection however with air valves, minimum seating pressure must be considered. Our standard range will handle low pressure ratings of 0.2 bar sealing pressure with 0.1 bar option across the range. A 0.02 bar sealing option is also available on selected models.

Air Valve discharge flows at 16 bar for standard UK stock products

Series 701/10 and 13, DN25 option - 175 cubic meters per hour.
Series 701/30, DN80 option - 1000 cubic meters per hour.
Series 701/40, DN50 option - 300 cubic meters per hour.
Series 701/50, DN80 option - 1100 cubic meters per hour.
Series 701/60, DN80 - 2775 cubic meters per hour.
Series 701/70, DN50 - 300 cubic meters per hour.
Series 701/75, DN80 - 300 cubic meters per hour.
Series 701/95, DN50 - 300 cubic meters per hour.

Working and test pressures

All air valves are body tested to 1.5 x working pressure and seat tested to 1.1 x working pressure. Test pressure and durations are carried out in line with EN12266-1.

Size Range

AVK offer DN12 to DN600, with variable inlet arrangements; BSP threaded and flanged.

Temperature

0 degrees to +70 degrees (90 degrees intermittently).

Installation

Designers should aim for vertical installation, however valves can accommodate a 5 degree offset from vertical. If the air valve is to be installed off line from the pipeline, a minimum of 7 degrees is recommended of rise in the branch pipe.

Relevant standards

All AVK water air valves carry the full WRAS approvals. Where applicable the flanges are to BS EN 1092.

Air Valve spares

Full internal spares, rolling seals, floats, retaining pins and bodies are available along with training on field maintenance procedures.

Maintenance

Recommended maintenance should be yearly, however each system should be reviewed in accordance with maintenance procedures and operating conditions. These will vary predominantly on waste water systems as to the FOG content of the fluids.

Isolation

AVK always advocate the use of an isolator with an air valve in order to facilitate isolation. Typically these can be ball valves, wedge/knife gate valves or butterfly valves, depending on the installation details and fluid type.



IF IN DOUBT ASK

TEL: +44 (0) 1604 601188

EMAIL: customerservice@avkuk.co.uk

AVOIDING NETWORK ISSUES

WATER HAMMER

How can AVK Control Valves help?

Control valves are regulating valves. They maintain certain pressure, flow or level regardless of changes in the supply network, and therefore help reduce water losses and contribute to efficient water supply.

Automatic control valves are used to obtain efficient flow management and pressure resulting in reduced:

- Risk of water hammer and pipe bursts.
- Water loss through leakages.
- Disruption to consumers.
- Minimized risk of contamination and increased savings for water companies.

Main Features - AVK Control Valves

The safe choice, offering accurate regulation, easy maintenance as well as long durability:

- All non-coated metal parts of stainless steel AISI 316 as standard.
- Fusion bonded epoxy coating (300 micron) - GSK approved.
- AVK's own, drinking water approved, rubber compounds.
- Speed for control for plug movement.
- Parabolic plug design to provide precise regulation and stability at low flow.
- Large diaphragm to secure fast reaction to minor changes in pressure.
- Lifted seat to prevent damage caused by cavitation inside the valve body.
- AVK design, manufacture and 100% pressure test.



CHOOSING THE CORRECT... AUTOMATIC CONTROL VALVE



Select the right Control Valve

The following conditions should be taken into consideration in order to select the right solution for your application:

- Working conditions.
- Maximum flow.
- Minimum flow.
- Continuous flow.
- Maximum inlet pressure.
- Minimum inlet pressure.
- Required outlet pressure.
- Pipe size.

Our online sizing tool provides guidelines for the selection. Find it at www.avkuk.co.uk on the tech support tab, under "Series 879 control valve information and specification tool".

Or scan here.



Strainers and Isolating Valves

It is highly recommended to install a protection strainer on the inlet side to filter out impurities that could damage the control valve. Isolating valves on each side of the control valve facilitate commissioning and maintenance.

AVK gate valves are available in a vast number of configurations. For isolating control valves, we recommend our standard flanged gate valve with short face-to-face length or the variant prepared for actuator.

Find in-depth information about our gate valves, visit www.avkuk.co.uk

Air Valves

In many cases it is recommended to install an air valve at the inlet of the control valve in order to avoid trapped air pockets in the system.

Air pockets may cause increased energy consumption and operation costs, pressure loss and increased risk of water hammer.

AVK air valves are available in many variants. For control valve installations, we recommend our combination air valves of ductile iron or reinforced polyamide.

Please refer to datasheets found via the AVK UK product finder at www.avkuk.co.uk

- 1- Gate Valve.
- 2- Air Valve.
- 3- Strainer.
- 4- Control Valve.
- 5- Fitting.

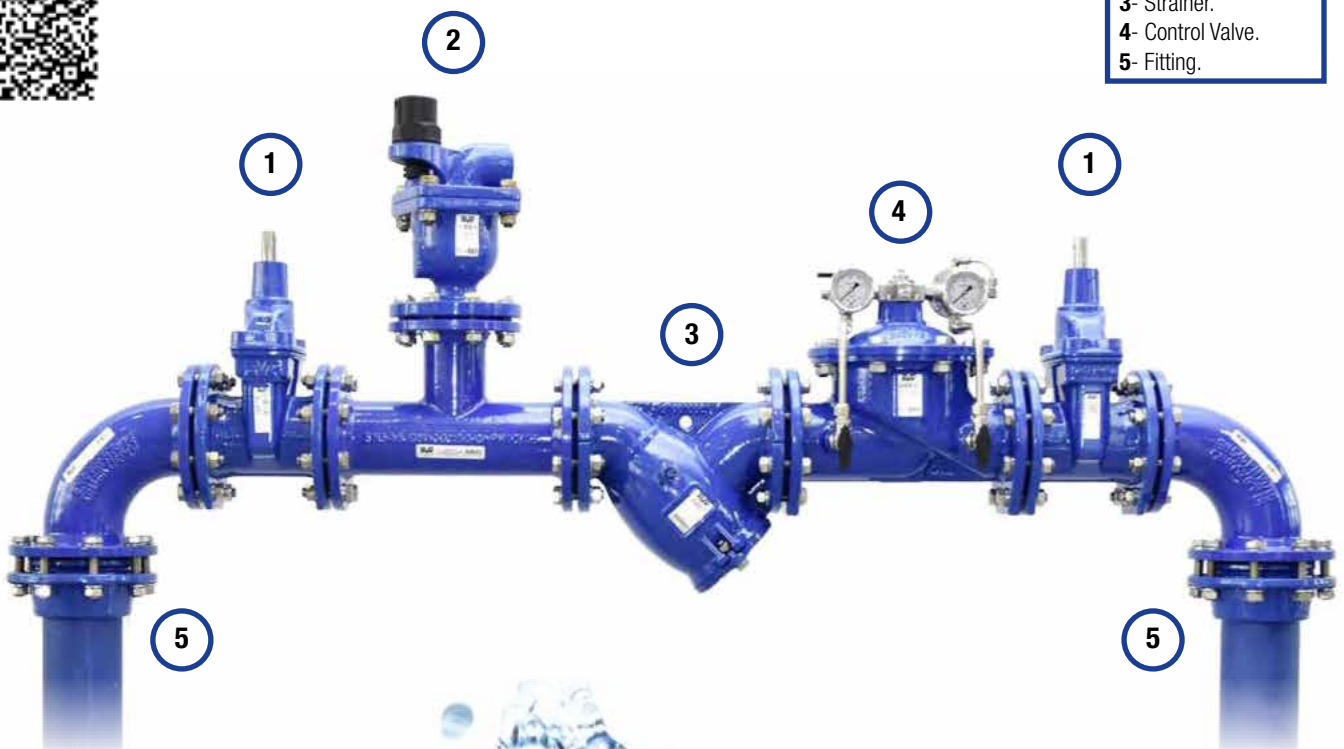

*Above image is an example, always use 5 x pipe diameter of straight pipe either side of control valve as industry recommendation.

CHOOSING THE CORRECT... AUTOMATIC CONTROL VALVE

SELECTION AND RECOMMENDATION

Water is a threatened resource. We have a responsibility to protect and secure water for the next generation and a growing population. AVK control valves (879) help towards reducing water loss and, by maintaining a certain pressure, flow or level, contribute to efficient water supply management regardless of changes in the supply network.

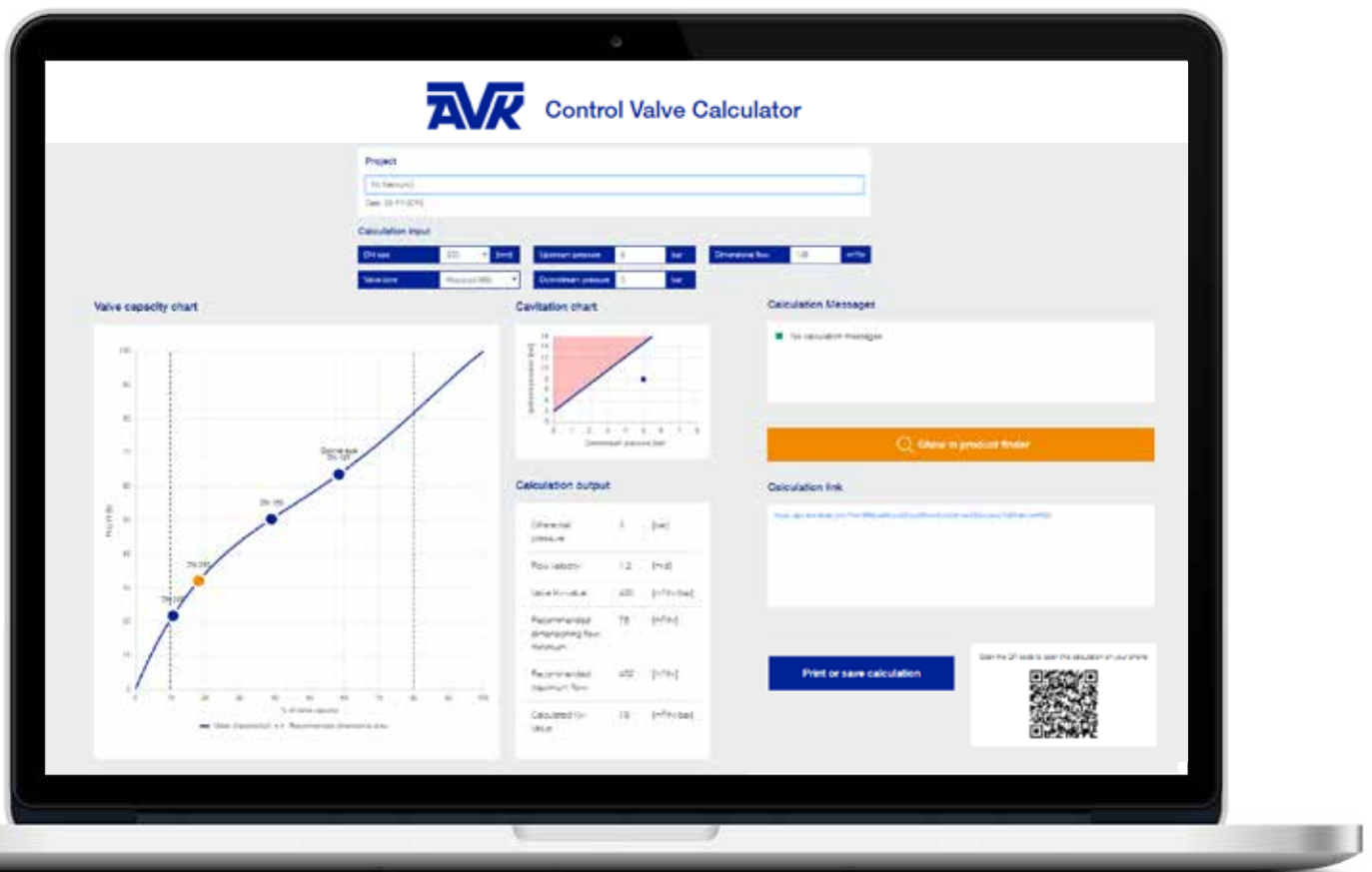

Our control valve calculator allows you to input your network information and obtain accurate data about the valve you require.

You can save and print your results and select the right product to meet your network needs.

In order to select the correct product for your application, the following information is required:

- Working conditions.
- Maximum inlet pressure.
- Maximum flow.
- Minimum inlet pressure.
- Minimum flow.
- Wanted outlet pressure.
- Continuous flow.
- Pipe size.

Try the calculator by scanning here.



CHOOSING THE CORRECT... AUTOMATIC CONTROL VALVE



AVK offer a wide range of automatic control valves for network safety. A selection of these are shown below.



Surge Anticipating Valve (Series 879)

This valve automatically opens to relieve overpressure. It protects the pipe system against pressure surges, mainly happening at pump start up or failures.

Operation

When the pump starts and stops gradually, surges do not occur. Both pilots of the control valve (negative and positive pressure) are closed. At power failure, the abrupt stopping of the pump results in a down surge in pressure. The negative pressure pilot senses the low pressure wave and opens the main valve. The valve anticipates the returning of a high pressure wave. If pressure increases until the preset value of the positive pressure relief pilot, the valve opens to dissipate energy. It closes slowly to prevent surges.



Pressure Sustaining/Relief Valve (Series 879)

This valve automatically maintains a minimum preset inlet pressure by relieving excess pressure, regardless of changes in flow rate.

Operation

The pressure sustaining pilot reacts to small changes in the inlet pressure, controlling the valve position. If the inlet pressure falls below the set point, the main valve closes or modulates to ensure a minimum inlet pressure. The sustaining valve holds a minimum back pressure on the inlet and normally allows flow. The relief valve normally remains closed and only opens when pressure exceeds a pre-determined set-point.



Level Control Valve (Series 879)

The diaphragm operated control valve, automatically controls the water levels in tanks or reservoirs. The altitude pilot senses the water level and opens to refill once the level drops 10 cm's below set-point.

Operation

The altitude control pilot reacts to small changes in the reservoir level, controlling the valve position. If the water level falls below the set point, the main valve opens or modulates to ensure a maximum water level. The altitude valve maintains a maximum level set point. The more the reservoir outlet flow increases, the more the pilot opens the main valve to compensate the level by increasing the inlet flow.



AUTOMATIC CONTROL VALVES ALL THE RANGE



SERIES 879/000X-001
AVK Pressure Reducing Control Valve
For use in water
DN65-300
PN16
Ductile Iron
BS EN 681-1
WRAS approved materials.



SERIES 879/001X-001
AVK Pressure Sustaining Relief Control Valve
For use in water
DN65-300
PN16
Ductile Iron
BS EN 681-1
WRAS approved materials.



SERIES 879/002X-001
AVK Flow Control Valve
For use in water
DN65-300
PN16
Ductile Iron
BS EN 681-1
WRAS approved materials.



SERIES 879/003X-001
AVK Level Control Valve
For use in water
One Way
DN65-300
PN16
Ductile Iron
BS EN 681-1
WRAS approved materials.



SERIES 879/100X-001
AVK Pressure Reducing Control Valve
For use in water
DN50-300
PN16
Ductile Iron
BS EN 681-1
WRAS approved materials.



SERIES 879/101X-001
AVK Pressure Sustaining Relief Control Valve (full bore)
For use in water
DN50-300
PN16
Ductile Iron
BS EN 681-1
WRAS approved materials.

Variants

Pressure control

- Pressure Reducing : SFM
- Low Pressure Reducing : SFM
- Pressure Sustaining : SFM
- Pressure Relief : SFM
- Pressure Reducing – Solenoid Shut Off : MFM
- Pressure Reducing – Pressure Sustaining : MFM
- Pressure Reducing – Pressure Sustaining Solenoid Shut off : MFM
- Pressure Reducing – Check valve : MFM
- Pressure Sustaining – Electric Shut off : MFM

Level control

- Float Level Valve : SFM
- Altitude Single Level – Solenoid Shut Off : MFM
- Altitude Single Level – Pressure Sustaining : MFM
- Altitude Single Level – Pressure Sustaining – Solenoid Shut Off : MFM
- Modulating Float Level – Solenoid Shut Off : MFM
- Modulating Float Level – Pressure Sustaining : MFM
- Modulating Float Level – Pressure Sustaining – Solenoid Shut off : MFM

Flow control

- Constant Flow : SFM
- Hydraulic Non Return Valve : SFM
- Constant Flow Solenoid Shut Off : MFM

Pressure management

- Dynamic Pressure Management.
- Dual Stage Pressure Management.
- Dual Stage Pressure Management (electric).
- Pressure Management Control Valve (with orifice plate).
- Pressure Management Control Valve (motorized).

Pump control

- Booster Pump Control : SFM
- Deep Well Pump Control.

SFM = Single Function Modules.
MFM = Multiple Function Modules.

AUTOMATIC CONTROL VALVES OPERATION & INSTALLATION



AVK diaphragm operated control valves for pressure sustaining/relief applications (PSV) automatically maintain a minimum inlet pressure, regardless of changes in flow rate or outlet pressure. The main control valve is pilot operated, capable of precise setting and easy adjustment of wanted inlet pressure sustaining, back pressure or hydraulic un-loading applications.

Size Range

AVK control valves are available in DN50-600, with reduced and full bore options. Control valves with reduced bore are appropriate for most applications, as the smaller bore often offers more accurate regulation. Control valves with full bore are recommended, if high Kv values needed, e.g. upstream of hydrants.

Installation

It is highly recommended to install a protection filter as well as isolating valves to facilitate commissioning and maintenance. If necessary install an air vent at the inlet of control valve.

Temperature

Automatic control valves are suitable for use on media to a maximum temperature range of -10° to $+70^{\circ}\text{C}$.

Maintenance

The valve is designed for underground or over-ground use and requires periodic maintenance. There are 2 common types of servicing procedures for hydraulic control valves, minor and major services.

Minor service: pilot system only (local service with valve online).

Major service: pilot and main valve (shut down required).

Service frequency should be scheduled depending on the operating conditions and consequence of failure of the valve. A valve operating in difficult conditions, such as high pressure differential should be maintained more frequently. Valves feeding high risk customers, such as hospitals should also be maintained more frequently.

All worn or damaged components can be easily replaced using standard tools.

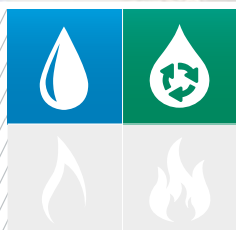

IF IN DOUBT ASK

TEL: +44 (0) 1604 601188

EMAIL: customerservice@avkuk.co.uk

AVOIDING NETWORK ISSUES

WATER HAMMER

How can AVK Non-Return valves help?

The amount of leakage and the increased risk of pipe bursts are amplified when high transient pressures occur in the system. For pumped installations, where the fluid requires to be 'lifted' from a lower level to a higher level, non-return valves are used to protect the pump and the system by reducing the risk of high transient (or surge) pressures.

When a pressure surge occurs, although it may only last for a very short time, it can amplify the normal system pressures by up to 10 times or more. This can damage the pipes, fittings and associated equipment installed on the line. Apart from the resulting costs and downtime these failures cause, the health and safety risks are also considerable.

Safety Critical Valves

The check valve allows the flow in only one (and always the same) direction thus preventing back flow when the fluid in the line reverses direction. The main importance of this function is twofold:

1. To prevent damage to upstream equipment that can be affected by reverse flows such as pumps and measuring equipment.
2. To prevent reverse flow after system shutdown (water hammer, see page 6).

Check valves are therefore safety critical valves that protect the system and its equipment from damage which can range from accelerated wear and tear to full, catastrophic system failure depending on the extent of the system design.

The importance of selecting the correct type, size and specification of check valve is crucial to ensure the running of the system is smooth, trouble free and provides long-term operation.

Selecting the correct Check Valve

Check valves are generally one of the least understood valve types and their importance is regularly overlooked. If these valves are incorrectly specified it can lead to major operational problems.

It is important to note that other factors are required to ensure a safe and trouble free system. The correct number, types and sizes of air valves, closing and opening times of isolation valves, flow control valves etc all require to be considered to protect the system from pressure surges.

To prevent the occurrence of check valve slam, the valve should close either very quickly to prevent the onset of reverse flow or very slowly once reverse flow has developed. For a check valve to close slowly, this requires additional ancillary equipment such as hydraulic dampers which act to cushion the valve door as it comes into its seated position, however, this slower closure does allow the fluid to pass through the check valve until it closes and consideration must be given to the upstream pump to ensure that it is suitable for reverse spin and flow.



CHOOSING THE CORRECT... NON-RETURN VALVE



Conventional Swing Check Valve (Series 41)

AVK's Series 41 conventional swing check valve is the most common member of the non-return family and is supplied with an extended bare shaft as standard that can be fitted with optional lever & weight and guard. The valve design provides a full bore opening which greatly improves the efficiency of the valve due to its low headloss characteristics. This valve is generally used for systems where the risk of pressure surges are low. Due to the full bore opening, this valve is commonly used in water and wastewater applications.

Recoil Check Valve (Series 641)

The recoil check valve is one of the oldest and most recognised types of high performance check valves. They are used in pumping systems where high rapid flow reversal takes place.

The recoil check valve is used for more extreme conditions and is designed to incorporate mechanical and hydraulic assistance for accelerating the closure of the door(s). Mechanical assistance is given by a combination of inertia reduction, concentration of mass and ideal suspension of the moving elements. Hydraulic assistance is given by the provision for forward and backward water streams within the body and around the valve door(s).

Each door has an integral concentrated mass which loads the door resulting in faster closure. The seating angle is inclined to reduce angular travel of the door and each door has its own individual stopper which controls and limits the door travel so that under normal flow conditions, the doors are held against the stopper, thus eradicating oscillations with flow, which would otherwise accelerate the bearing wear.

For larger valve sizes, a multi-door design is used. By sharing the volume of flow by two, three or even four doors, this reduces the required angular travel of each door, thus reducing the closure times of the doors. Apart from the fast-acting closure of the recoil valve, because all hydraulic and mechanical features are incorporated into the actual valve, there is no requirement for additional options such as levers, weights, dampers or springs. As such, the recoil check valve is a self-contained product that requires practically zero maintenance. Recoil valves are generally used in water systems and are not recommended for sewage applications due to the potential for ragging within the valve. These valves are suitable for horizontal installations only.

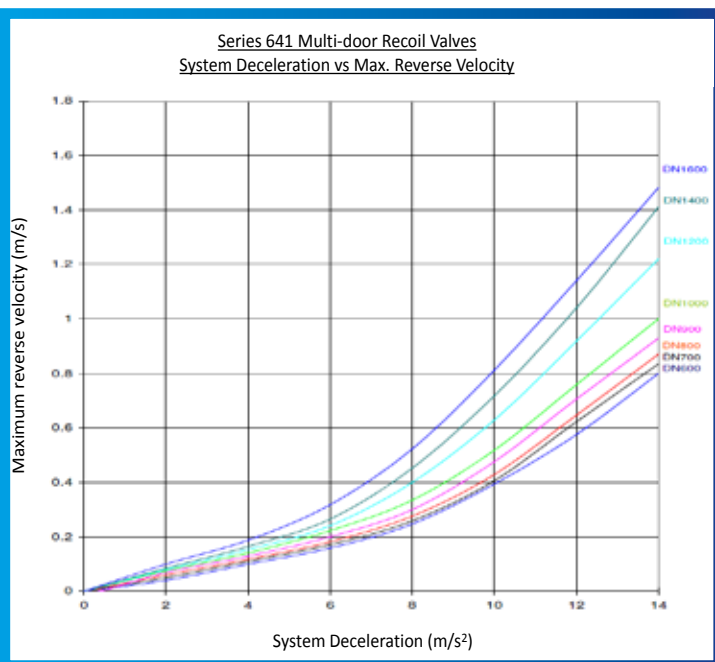

Shock pressure comparative test between recoil and conventional swing check valves.
Recoil valve eliminating 97.5% shock pressures.

CHOOSING THE CORRECT... NON-RETURN VALVE



Nozzle Check Valves (Series 876)

The nozzle check valve has a double flanged valve body with a venturi type internal profile. The valve disc is connected to a stem which is guided on the central horizontal axis. A spring is positioned between the disc and the diffuser sleeve. When flow enters the valve, the hydraulic force exerted onto the front face reacts against the spring, causing the spring to compress and allow the valve to open. When the flow stops, the spring forces the disc to return to the closed position. The disc surface is resilient, providing a drop-tight seal against the body seat. Nozzle check valves up to DN300 are designed based on a single stem / disc design. Similarly to the aforementioned recoil check valves, larger nozzle check valves tend to have a multi-stem / disc arrangement. This ensures that the disc travel is minimised thus reducing the closure time.



Due to the spring-assisted closure and the short linear valve stroke, the nozzle check valve is one of the quickest acting check valves available and is commonly used in pumped systems where water hammer is a potential concern. Because the disc is constantly in the direct line of flow, the head loss characteristics of this valve are higher compared to that of conventional swing check valves. In systems with potential water hammer, the superior performance and increased protection to the system that the nozzle check valve offers far outweighs any slight increase in head loss across the valve, because of the obstruction in the flow path, nozzle check valves are used in water and finely treated effluent pumped systems.

Ball Check Valves (Series 53)

Because of their clear bore design, ball check valves are commonly used in waste water applications. This check valve type consists of only a few components; the body, cover and ball. The body is generally flanged but can also be threaded. The internals of the body provide a full and smooth bore ensuring full flow with low head loss across the valve. This design also ensures that no solid deposits can build up at the base of the valve. The ball rotates during operation eliminating the risk of impurities getting stuck on the ball.

During flow conditions, the fluid makes contact with the ball and is guided up via contours into the top chamber of the body just below the cover. When the forward flow ceases, the ball returns back to the closed position due to gravity and seals onto its seat preventing reverse flow.

Further to the aforementioned low head loss and unobstructed flow path, these valves are also relatively economical and can be installed in both the horizontal or vertical orientations as standard. Due to the simple nature of the operation and the small number of moving parts, ball check valves require very little maintenance. When maintenance is required, the ball check valve can be accessed from the top and can be maintained with the body installed onto the pipe. Different ball masses can be provided to modify the closing characteristics of the valve to meet the conditions of the system. These valves are not used for installations where there is a high risk of water hammer as they are not particularly fast closing compared to other check valve types. This is mainly due to the ball not being in direct contact with the reverse flow.

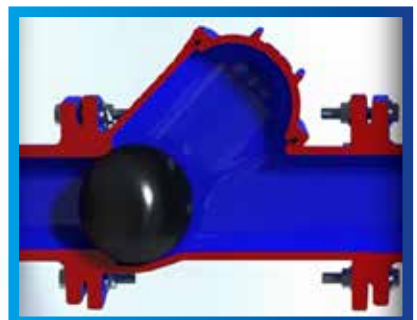

CHOOSING THE CORRECT... NON-RETURN VALVE

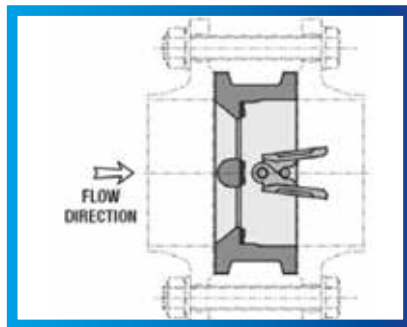
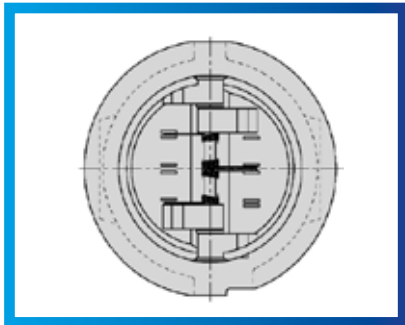

Double Disc Check Valves (Series 642)

Also known as the butterfly check valve, the dual disc check valve is a maintenance free, self-acting pivoting check valve of the double disc wafer type. This valve is particularly useful for installation in pipelines due to its compact design and very short face to face dimensions.

The short cylindrical body is usually of the wafer type and has a centric shaft design which is inserted into the body. Torsional springs are fitted onto the shaft which hold the discs in a closed position in zero flow conditions. When flow passes through the valve, the hydraulic force exceeds the spring force and causes the discs to open parallel to the axis of flow. The resilient seal is fixed onto the internals of the valve body so that when the metallic discs are fully closed, they provide leakage-free sealing performance.

Tilting Disc Check Valves (Series 874)

The tilting disc check valve is similar in appearance to an eccentric butterfly valve. The valve body is double-flanged and of a short length. The disc is held in place via a shaft which is positioned eccentrically from the body centreline in both the horizontal and vertical axes. Higher quality products have stoppers attached to the disc which limits the valve opening and ensures that the disc remains in a more static position when subjected to sufficient flow rates. This reduces the wear and tear of the rotating components of the valve and also provides stable and consistent head loss characteristics during operation.

The substantial double eccentricity of the shaft results in the lower section of the disc occupying a greater area in the flow path. Consequently, the disc begins to open at very low flow rates. The tilting disc check valve is therefore commonly used in pumping systems with low flow rates and also for pulsating flows.

During flow reversal, the disc closes due to gravity and the upper part of the disc above the shaft centreline pushes against the flow thus acting as a hydraulic brake which cushions the disc as it returns to the closed position. Tilting disc valves can be supplied with optional levers and weights to adjust the closing characteristics of the valve.

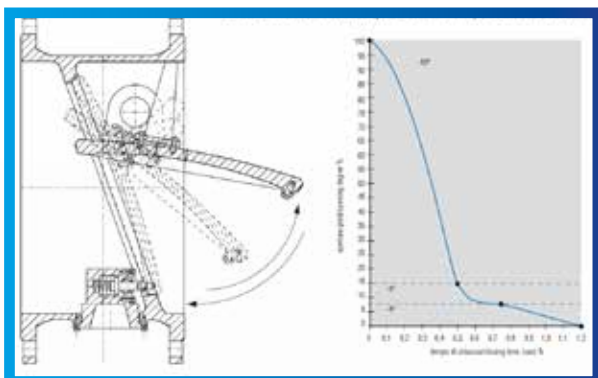
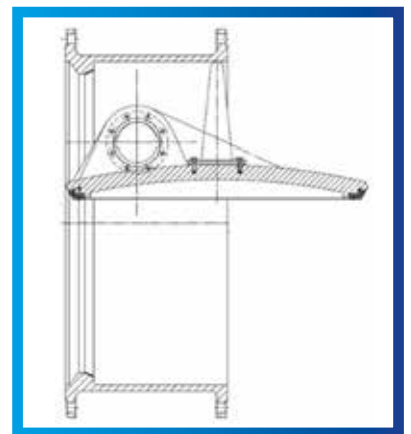

Slanted Seat Check Valves (Series 875)

Like the tilting disc check valve, the slanted seat offers enhanced resistance to water hammer. The valve has the double eccentric shaft position similar to the tilting disc but it also has an increased seating angle. This yields a shorter valve stroke, thus reducing the time taken for the door to close. The slanted seat check valve can be installed with an optional hydraulic damper which is located at the internal base of the valve body.

The valve disc closes quickly over the first 85% of its angular travel before coming into contact with the hydraulic damper. The damper then dissipates the kinetic energy of the disc and forces it to open slightly. The disc closes until it contacts the damper again and this cushions the disc until it returns to its fully closed position, sealing the valve. This function greatly reduces the onset of water hammer due to the damped and controlled method of valve closure.



NON-RETURN VALVES ALL THE RANGE

SERIES 41/20

AVK Resilient Seat Swing Check Valve.
For use in water/wastewater
DN50-300
PN16

Ductile Iron
BS EN 1074-3
BS EN 1092-2 (ISO 7005-2)
EN 558-1 Series 48

Easy access to maintenance simply by unscrewing a few bolts and lifting the bonnet assembly.



SERIES 41/36

AVK Swing Check Valve with Lever and Weight.
For use in water/wastewater
DN350-600
PN16

Ductile Iron
EN 558 Series 48
BS EN 1074-3
BS EN 1092-2 (ISO 7005-2)

Easy access to maintenance simply by unscrewing a few bolts and lifting the bonnet assembly.



SERIES 41/39

AVK Metal Seat Swing Check Valve.

For use in water/wastewater
DN50-300
PN10/16

Ductile Iron
EN 558 Series 10
BS EN 1074-3
BS EN 1092-2 (ISO 7005-2)

Easy access to maintenance simply by unscrewing a few bolts and lifting the bonnet assembly.

SERIES 53/30

AVK Threaded Ball Check Valve.

For use in wastewater
DN32-50
PN10

Ductile Iron
EN 12050-4
DIN 3202-F6

The ball rotates during operation eliminating the risk of impurities getting stuck.



SERIES 53/35

AVK Flanged Ball Check Valve.

For use in wastewater
DN65-500
PN10

Ductile Iron
EN 12050-4
BS EN 1092 (ISO 7005-2)
DIN 3202-F6

The full and smooth bore ensures full flow with low pressure loss and eliminates the risk of deposits at the bottom.



SERIES 53/40

AVK Threaded Ball Check Valve.

For use in wastewater
DN40-50
PN10

Stainless Steel
EN 12050-4
DIN 3202-F6

The ball is optionally available in polyurethane suitable for abrasive media and if different ball weights are necessary to prevent vibration and water hammer.

SERIES 641/01

AVK Metal Seat Swing Check Valve.

For use in water/wastewater
DN700-1000
PN16

Ductile Iron
BS EN 1074-3
BS EN 1092-2 (ISO 7005-2)

The ball rotates during operation eliminating the risk of impurities getting stuck.



SERIES 641/11

AVK Recoil Check Valve.

For use in water/wastewater
DN100-500
PN16

Ductile Iron
BS EN 1092-2 (ISO 7005-2)
Delivered with NBR lined ball as standard and optionally with ball of polyurethane available in different weights.



SERIES 641/21

AVK Recoil Check Valve.

For use in water/wastewater
DN600-1200
PN16/25

Ductile Iron
BS EN 1092-2 (ISO 7005-2)
Fast acting, non-slam check valve used to prevent flow reversal.

SERIES 876

Nozzle Check Valve
DN50 - 600
PN10/16

Ductile Iron Body
Bronze Seat
EN558 - Series 14



SERIES 874

Tilting Disc Check Valve
DN150 - 1600
PN10/16

Ductile Iron Body
EPDM Seal
EN558 - Series 14

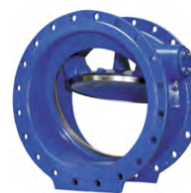

SERIES 875

Slanted Seat Check Valve
DN200 - 1000
PN10/16

Ductile Iron Body
SS Seat
EN558 - Series 14

SERIES 642

Double Disc ECV "Eurocheck" Check Valves

DN32-600
PN6/10/16

Ductile Iron Body
EPDM or NBR Liner
EN 558 - Series 16



NON-RETURN VALVES OPERATION AND INSTALLATION



Non return valves are primarily fitted in pumping applications (but not limited to) where the valve is used to prevent the return flow of media. This range consists of a basic flap design which is secured to the valve shaft internally. This shaft can be extended through the valve body and fitted with an adjustable lever and weight. This adds mass to the door allowing a quicker closing time. The closing speed of a check valve can be critical to the system preventing hydraulic surge. Standard non return valves are suitable on a wide range of media; potable water to raw sewage. The standard non return valve detailed in this chapter CANNOT be described as a NON slam recoil variety.

Sealing Types

AVK UK offers a resilient seated valve, as shown left, DN50– DN300. This refers to the seating face of the valve which has a rubber coated disc and allows for drop tight closure. Additionally AVK UK offers DN50 –DN1000 as metal seated valves.

Flow Details

To ensure a long and maintenance free usage, non return valves should be sized according to flow and not typically pipeline size. Door flutter and over wear of the valve stem can occur should the valve be incorrectly sized. Standard non return valves should be limited to 2 to 2.5 metres/sec pipeline velocity.

Installations

Non return valves should be sited not less than 5 times the valve diameter downstream of any elbows, tees etc. Please refer to AVK UK installation and maintenance instructions for full details.

Vertical Applications

Smaller diameter valves (<600mm) can be mounted vertically on clean water applications only with upwards flow. Lever and weights would require to be fitted to suit this application - suitably guarded - a mandatory health and safety requirement (*see below innovations).

Temperature

Non return valves are suitable for use on media to a maximum temperature range of –10° to +70°C.

Valve Variants

The series 41/39 (metal seated) and 41/20 (resilient seated) valves are available in 4 variants:-

Basic Valve – This valve has no lever weight fitted.

Free end shaft – This valve has an extended shaft protruding from the valve body and can be retrofitted with a lever and weight.

Lever and weight (LW) – The valve is supplied with lever and weight components. All moving parts must be guarded * - a mandatory health and safety requirement.

Lever and weight with guard (LWG) – The valve is supplied with lever, weight and guard components. All moving parts must be guarded *- a mandatory health and safety requirement.

Switches

Where a switch is required to show end of travel position, this can be supplied as a proximity or a standard limit switch. Care should be taken to identify atmospheric conditions in particular zoned requirements and ensure that this information is made clear at time of enquiry. Note also that cable lengths typically come in 1 to 2 metres lengths as standard. Longer cable lengths (10 metres) can be supplied where a zoned area demands, however this must be requested at time of enquiry. Switches can be retrofitted - please refer to AVK UK operation and maintenance manuals for health and safety requirements.

Maintenance

The valve is designed for underground use with minimum maintenance and requires no lubrication. In the event of a spares replacement becoming necessary, the recommended procedure can be found at www.avkuk.co.uk/en-gb/product-finder.



IF IN DOUBT ASK

TEL: +44 (0) 1604 601188

EMAIL: customerservice@avkuk.co.uk

*This information is for conventional swing check valves. Any other check valve that is mentioned in this brochure, technical information can be found on our website.

ASSOCIATED PRODUCTS

NON-AUTOMATIC FLOW CONTROL VALVES



Needle Valve (Series 872)

The AVK needle valve is a non-automatic control valve that is used to control the flow and pressure in a water system. When it comes to network safety, the needle valve can be used to control both upstream and downstream pressures. When correctly sized according to the hydraulic parameters of the system, the needle valve is installed directly on the pipe between an upstream and downstream pressure gauge. By changing the position of the internal plunger within the needle valve, it is possible to increase or decrease the area of the fluid flow, thus adjusting the upstream or downstream pressures.

The needle valve is normally used in “smart environments” because they can be controlled by a PLC system. When used with electrical actuators, this allows fantastic flexibility in managing the system pressures and flow rates. A remote control set-up can optimize the system pressures and flows for the distribution network or to the tanks / reservoirs automatically 24 hours per day. This can ensure that the water resources available are optimised and that leakage rates in the system are reduced, increasing system efficiency, saving energy and money for the supplier and consumer.

NEEDLE VALVE: flow analysis and cavitation check

Upstream and downstream reservoirs at constant level

Valve specification	
Project	19_2535_DN350NV.
Description	DN 350 PN 16 - Standard (C)
Nom.diam. DN	350
Nom.press. PN	16
Anticavitation cylinder	Standard

	A	B
Flow rate	Q 164,0	31,0 [l/s]
Flow rate	Q 164,0	31,0 [l/s]
Upstream pressure (dynamic)	P _{in} 3,65	3,65 [m]
Downstream pressure (dynamic)	P _{out} (*) 1,25	1,25 [m]
Pressure drop (valve)	ΔP _v 2,40	2,40 [m]
Flow velocity	v 1,70	0,32 [m/s]
Approx.valve opening	α 59%	28%

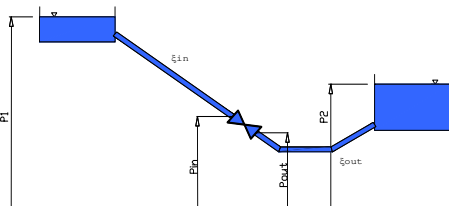

Pipe press.drops coeff.

Upstream pipe	ξ_{in}	0,00	[...]
Downstream pipe	ξ_{out}	0,00	[...]
Upstream reservoir level	P1	3,65	[m]
Downstream reservoir level	P2	1,25	[m]

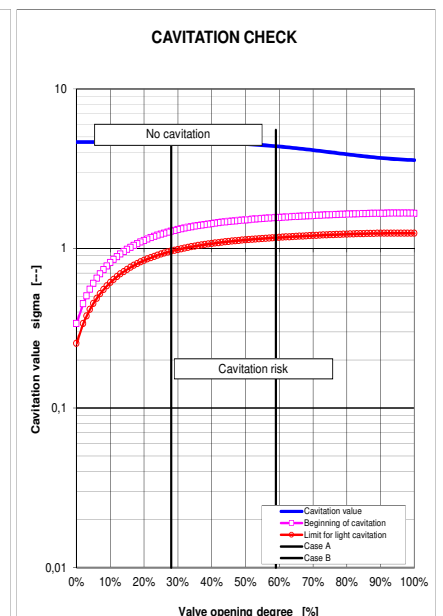
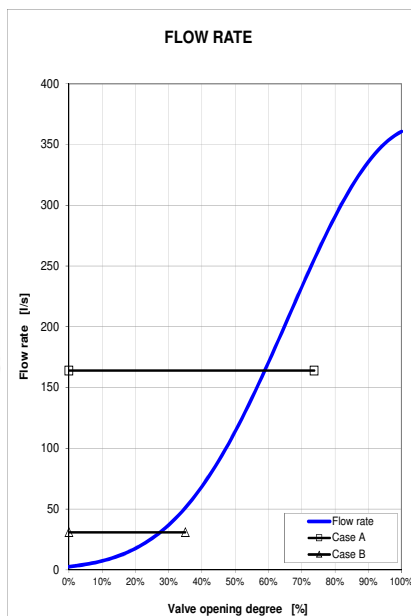

The AVK needle valve can be offered in high pressure applications and can be installed with anti-cavitation trim devices for arduous system conditions.

Eccentric Plug Valve

Another non-automatic control valve offered by AVK is the eccentric plug valve. This is used for similar applications to the needle valve in that, it is used to control the flow and pressure, but is more generally used in wastewater systems.

Like the needle valve, the eccentric plug valve can be installed directly on the pipe between an upstream and downstream pressure gauge. By changing the position of the internal plug, it is possible to increase or decrease the area of the fluid flow, thus adjusting the upstream or downstream pressures.

The design of the plug valve allows solids and debris to pass through the valve due to its rotational mechanism which results in a larger flow passage compared to the needle valve. It is because of this feature that this valve is used commonly in wastewater installations.



ASSOCIATED PRODUCTS WIDER RANGE



AVK provide high quality products for your network safety needs. Our products are of the highest quality, we manufacture resilience for long lifetime products and fittings that reduce leakage and shutdown times. A selection of these are shown below.



Safety valves that are relied upon for water release and also to allow monitoring of the network conditions. Anti-tampering devices important to prevent unaccounted release of water and vandalism for fire brigades.

AVK Fire Hydrants



AVK Fire Hydrants Accessories

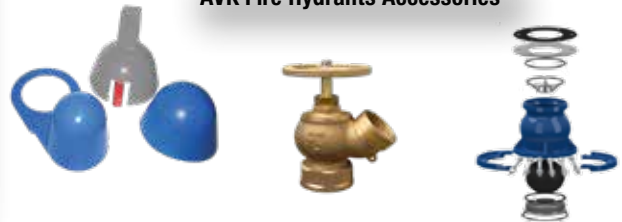

AVK Isolation Valves



A more simple valve, it's critical that any gate or butterfly valves have quality, reliability and longevity to ensure that the network can operate under safe working conditions and can also be activated remotely.

AVK Fittings



Used to limit the amount of leakage and protect against inflow of contaminants through cracks in pipes.



*Note: At time of print product information is correct.



WATER AND WASTE WATER ENGINEERED SOLUTIONS



T: +44 (0) 1604 601188
E: projects@avkuk.co.uk

TECHNICAL INFORMATION

Online product selection.
PDF brochures.
Websites.
Video tutorials.
Interactive animations web shops.
2D drawings.
3D drawings.
Technical documents.

ENGINEERING

Network modelling.
CFD analysis.
FE analysis.
Hydraulic system calculations.
Fluid test laboratory.

SUPPORT

Engineering and site solutions.
Sustainable smart water management solutions.



Maidstone
T: +44(0) 1622 754613
Kilmarnock
T: +44(0) 1563 521150
E: enquiries@glenfieldinvicta.co.uk

ONE TEAM MANY SOLUTIONS

Within our vast range of capabilities we can provide a comprehensive range of engineering and site solution packages. Our specialist teams come to you to identify the perfect solution - from feasibility and site audit to network leakage management and repair.

Our product range from DN12-3000+ includes an extensive range of:

- Wedge gate valves.
- Parallel faced gate valves for dams and reservoir applications.
- Butterfly valves.
- High performance recoil check valves.
- Needle control valves.
- Free discharge, cone, hollow jet valves.
- Submerged discharge valves.
- Plug valves.
- Air control valves.
- Automatic pressure and level control valves.
- Penstocks, sluice and roller gates.
- Stop logs.
- Bellmouths.
- Flap valves.

Engineered and Site Solutions:

- Site surveys and health checks.
- Supply, installation, refurbishment and replacement.
- Design and manufacture of ancillary equipment.
- All associated enabling, electrical and civil engineering services.
- Equipment commissioning.
- Scheduled maintenance and servicing contracts.
- Extended warranties.
- Post contract training.
- UK coverage.
- Bespoke fabrication services.



Water Supply

Waste Water

Fire Protection

Gas supply

Solutions and Information

Change website

- NEWS
- DOWNLOADS
- CASE STUDIES
- AVK IN THE UK
- CONTACT
- ENQUIRY
- MY AVK
- AVK GROUP

Find product

Search



AVK World Visualisation

INTRODUCING THE NEW AVK WEBSITE

Scan Here.



With a completely fresh look and functionality, this new, advanced solution is easier to navigate and information easier to access with increased product visibility, identification and selection.

The updated Product Finder, the principal selection tool, offers greater product information at-a-glance while the new, "AVK World" visualisation is very exciting and a great guide to product selection, application, installation and links to the product represented.



Click on the sector.

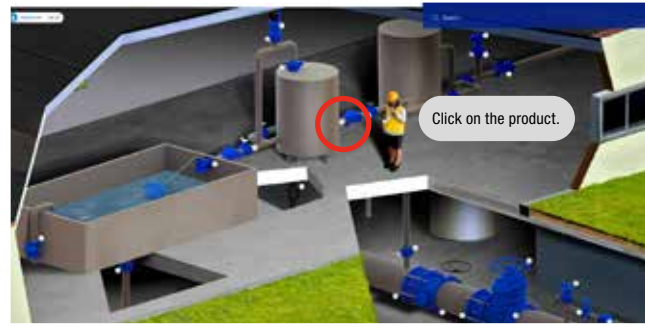

Click on the product.

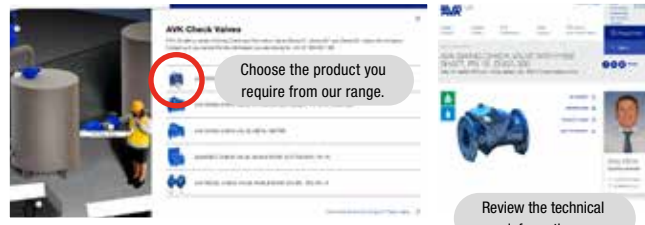

Choose the product you require from our range.

Review the technical information.

**AT AVK WE TAKE CUSTOMER
EXPECTATIONS TO A HIGHER LEVEL**



CUSTOMER PROMISES

EXPECT SOLUTIONS, NOT ONLY PRODUCTS

**EXPECT GLOBAL LEADERSHIP AND
LOCAL COMMITMENT**

EXPECT QUALITY IN EVERY STEP

EXPECT PROMPT RESPONSE

EXPECT LASTING INNOVATIONS

EXPECT TOTAL SAVINGS

EXPECT A LONG-TERM PARTNERSHIP

EXPECT IT TO BE EFFECTIVE AND EASY





AVK UK

8 Rushmills
Northampton
NN4 7YB
England, UK

Tel: +44 (0) 1604 601188
Email: customerservice@avkuk.co.uk

